



Gate Survey

Date:

Name:

Type of Installation: (residential/ multi residential / school / industrial)

Site Address:

Customer Address:

Customer Contact No.

Email:

Swing Gates

1. Please tick the correct box, is the gate on site

Single leaf

Double leaf

2. Are the gates currently automated?

Yes

No

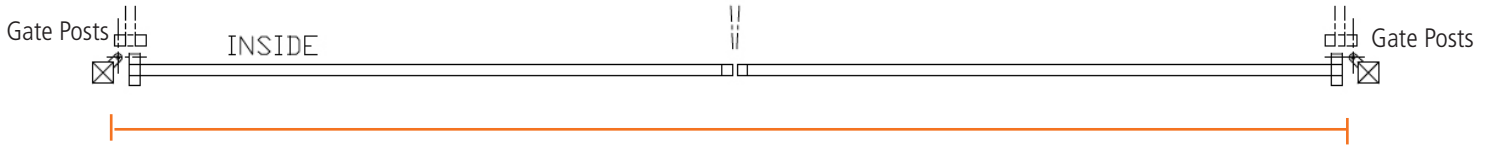

2. Distance between gate posts

3. Bottom hinge position to the ground

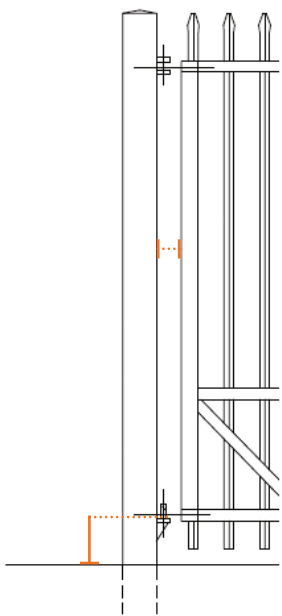

Measurement between gate leaf and post/pillar

Left Hand Side

In OPEN position Measurement

In CLOSED position Measurement

Right Hand Side

In OPEN position Measurement

In CLOSED position Measurement

Please take measurement from top of the hinge to the ground

Left hand Post VFO Measurement

Right hand Post VFO Measurement

Measurement under gate leaf

Left hand

In OPEN position Measurement

In CLOSED position Measurement

Right Hand

In OPEN position Measurement

In CLOSED position Measurement

4. Distance between hinge positions

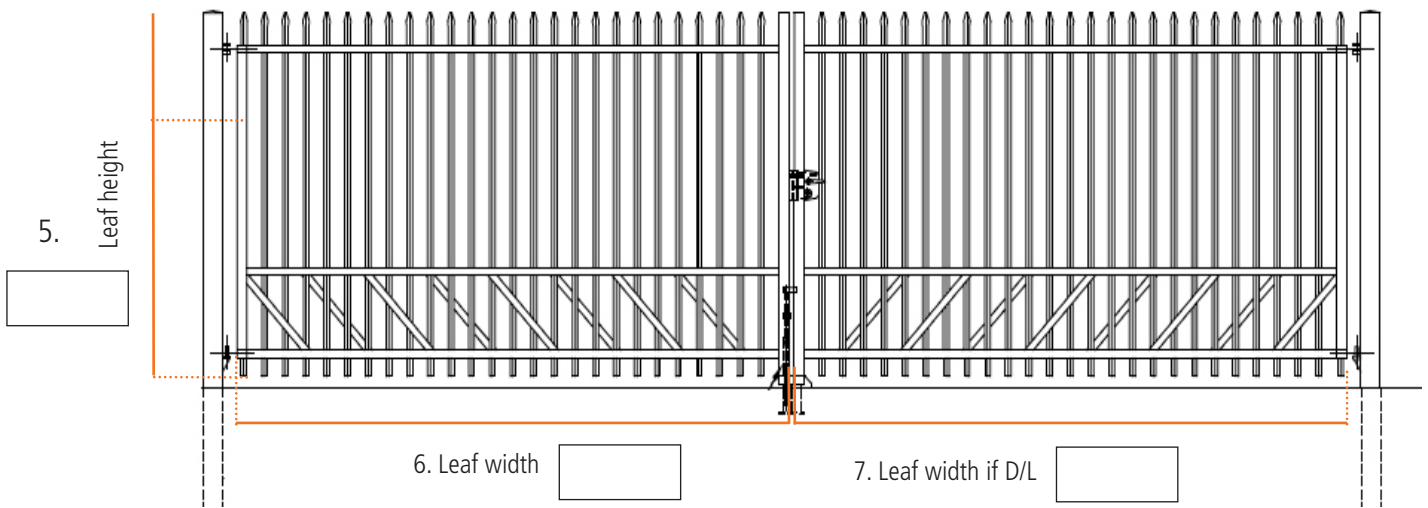
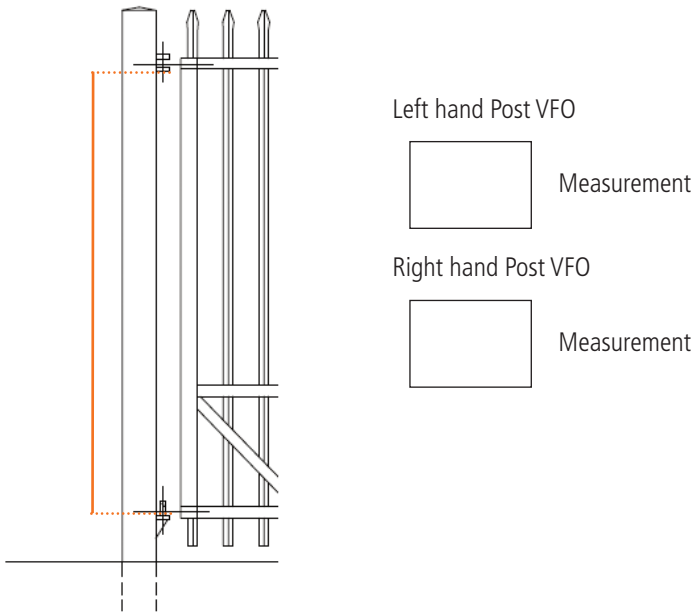

6. How many times is it used a day?

Maximum opening angle of the gate

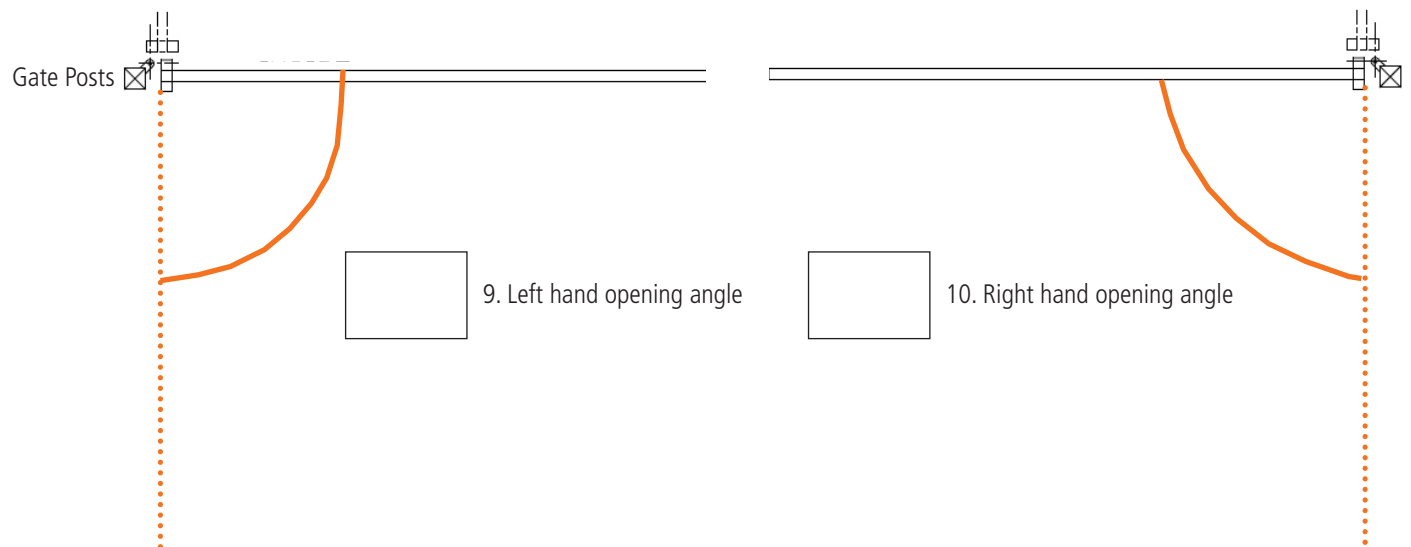

7. Type of gate i.e open infill, courtyard

8. Hinge Position

In open and closed position

Left Hand Hinge

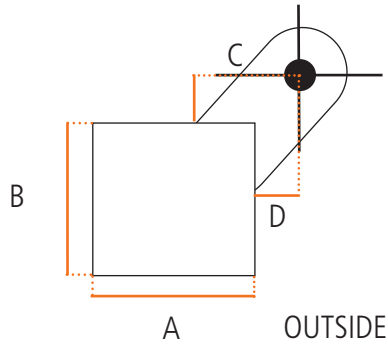

Measure

A=

B=

C=

D=

Right Hand Hinge

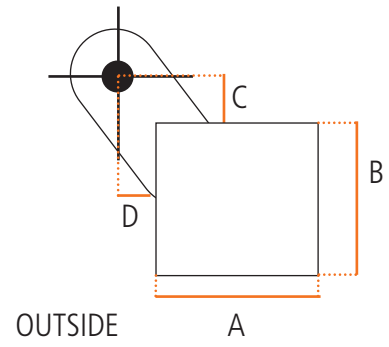

Measure

A=

B=

C=

D=

9. Gates hung behind

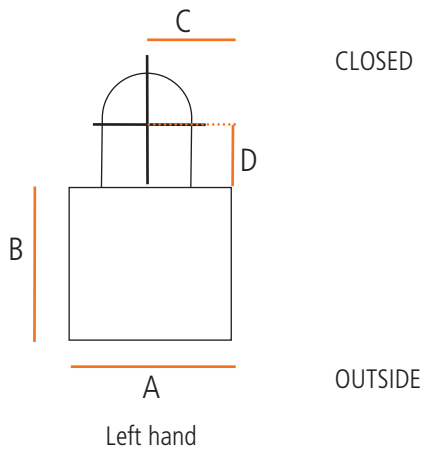

Measure

A=

B=

C=

D=

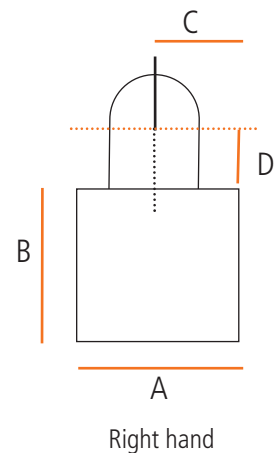

Measure

A=

B=

C=

D=

10. Gates hung between

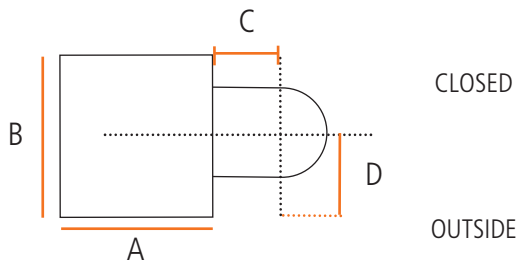

Measure

A=

B=

C=

D=

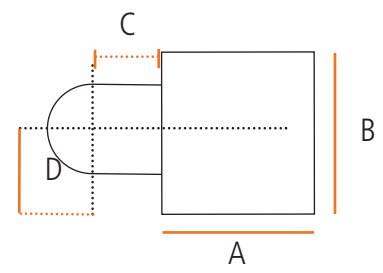

Measure

A=

B=

C=

D=

Swing Gate Automation

End Stile of Gate (size)

	YES	NO
1. Has the gate got a centre gate stop?		
2. When the gate is in the open position is there a physical gate stop?		

1. Has the gate got a centre gate stop?

2. When the gate is in the open position is there a physical gate stop?

3. What is the gate made from? (i.e End stile size and what is it made from?)

4. If the gate is an open infill please state the pail pitch and size

5. Is the gate mechanically / structurally sound? i.e not falling apart, is there any play on the hinges

6. If the gate is automated what safety devices have been employed?

Safety edges

Photocells

Light curtain

No. of safety edges _____ Position _____

No. of photocells _____ Position _____

No. of light curtains _____

7. Automation equipment fitted (cabinet will need to be opened)

Manufacturer: (Operator and control panel)(photo if possible)

Type of automation equipment (if known).....(photo if possible)

	YES	NO
8. If photocells are fitted does the gate stop and reverse in the closing phase of operation?		
9a. In the opening phase does the gate stop?		
9b. If the photocells are blocked and the gate receives an open input does the gate open?		

8. If photocells are fitted does the gate stop and reverse in the closing phase of operation?

9a. In the opening phase does the gate stop?

9b. If the photocells are blocked and the gate receives an open input does the gate open?

YES	NO

10. If safety edges are fitted do they cover up to 2.5m high?

11a. What happens to the gate if the safety edges are activated in the closing phases? STOP or CARRY ON

11b. What happens to the gates if the safety edges are activated in the opening phases? STOP or CARRY ON

YES	NO

12. Can the gates be easily "stalled" during operation i.e stopped by hand?

Impact and Crushing

YES	NO

13. During opening does the gate leaf open up to a solid obstacle which is at least 500mm or under 200mm for more than 250mm in length?

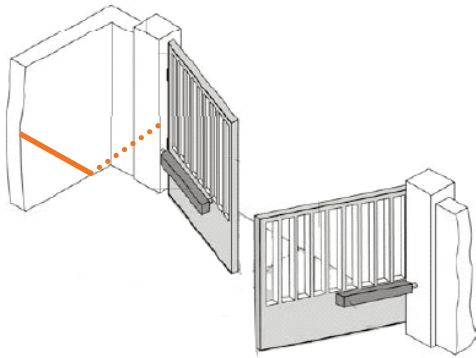

YES	NO

14. If the gate is fitted with a gate hinge operator does the operator come at least than 500mm from the obstacle?

YES	NO

15. During closing on a double leaf gate as the gate comes together does one gate leaf close before the other?

16. What type of access control has been installed?

For entry

For exit

17. Detail locations of entry and exit equipment

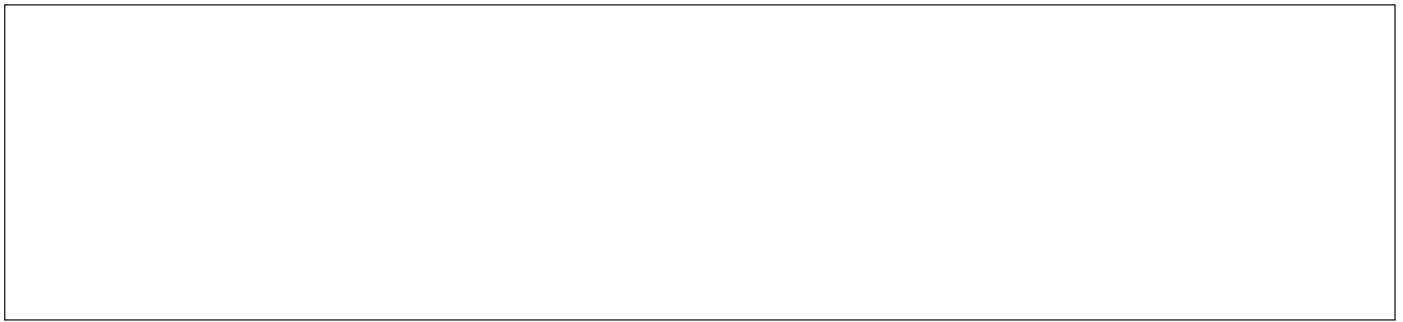
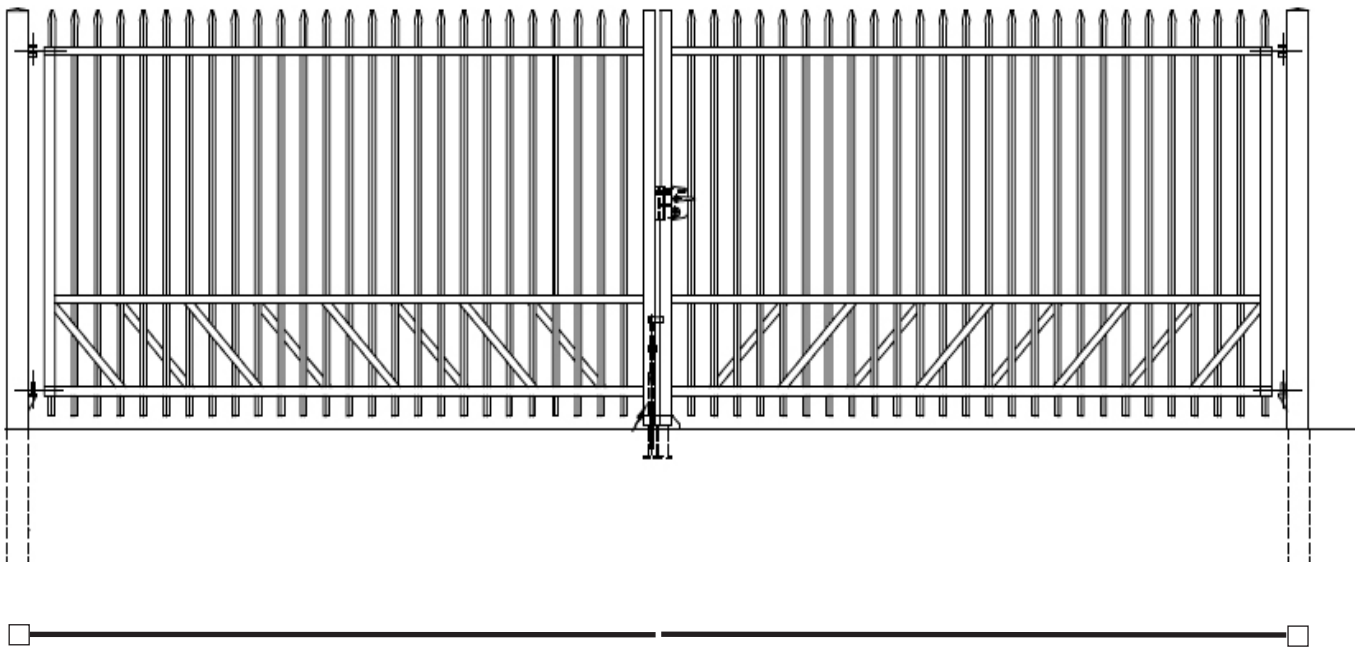

Sliding Gates

1. Please tick the correct box, is the gate on site

Single leaf

Double leaf

2. Are the gates currently automated?

Yes

No

3. Tracked

Sliding

4. Clear opening mm

5. Gate leaf height mm

6. Number of support posts?

7. Support posts
Height mm

Size mm

8. Number of uses per day?

9. Style of gate i.e open fill, mesh or solid

YES

NO

10. Has the gate got physical stops in both fully open and closed position?

11. If the gate has an open infill please state the pail pitch mm

12. What is the size of the end stiles of the gate leaf? mm

13. Is the gate mechanically sound? any signs of damage or wear on the rollers?

Sliding Gates Automation

14. If the gate is automated what safety devices have been installed?

Safety edges

Photocells

Light curtain

15. Automation equipment fitted

Manufacturer: (Operator and control panel)

Type of automation equipment (if known).....

YES	NO
-----	----

16 a. If photocells have been fitted does the gate stop and reverse in the closing phase of operation?

16 b. What height are they and how many pairs?

17. What happens in the opening phase?

YES	NO
-----	----

18. If the safety edges fitted, do they cover up to 2.5m high if the whole height of the gate is up to 2.5m?

YES	NO
-----	----

19a. In the opening phase does the gate stop?

YES	NO
-----	----

19b. If the photocells are blocked and the gate receives an open input does the gate open?

YES	NO
-----	----

20. Can the gates be easily "stalled" during operation i.e stopped by hand?

Impact and Crushing

201. Does the gate open up to a solid obstacle within 500mm of the full open position?

YES / NO

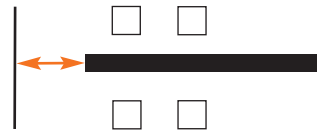

YES	NO

22. Does the gate open up against open infill fencing?

23. If so what is the distance between the fence and gate?

24. Is the gate or fencing meshed?

YES	NO

25 b. If YES what size is the mesh?

26. What type of access control has been installed?

For entry

For exit

Detail locations of entry and exit equipment

